



RONDO-150 / RONDO-160

Frameless ventilation diffuser

Technical specification



reddot winner 2023

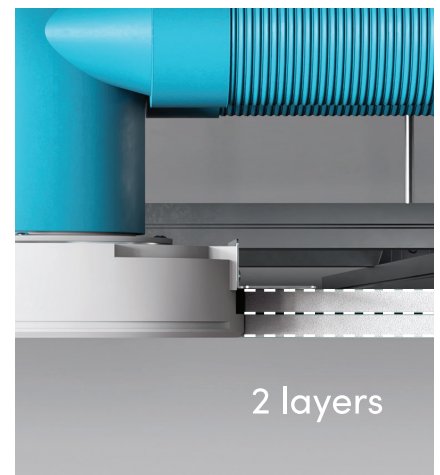
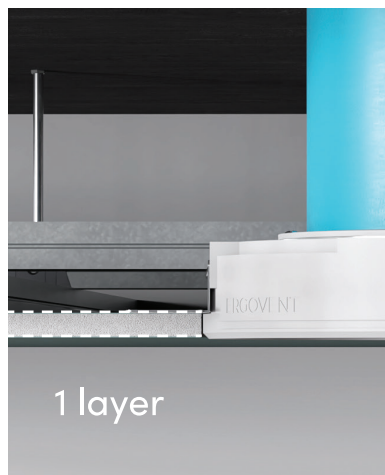
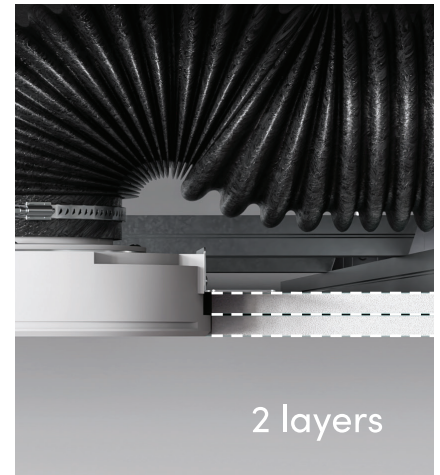
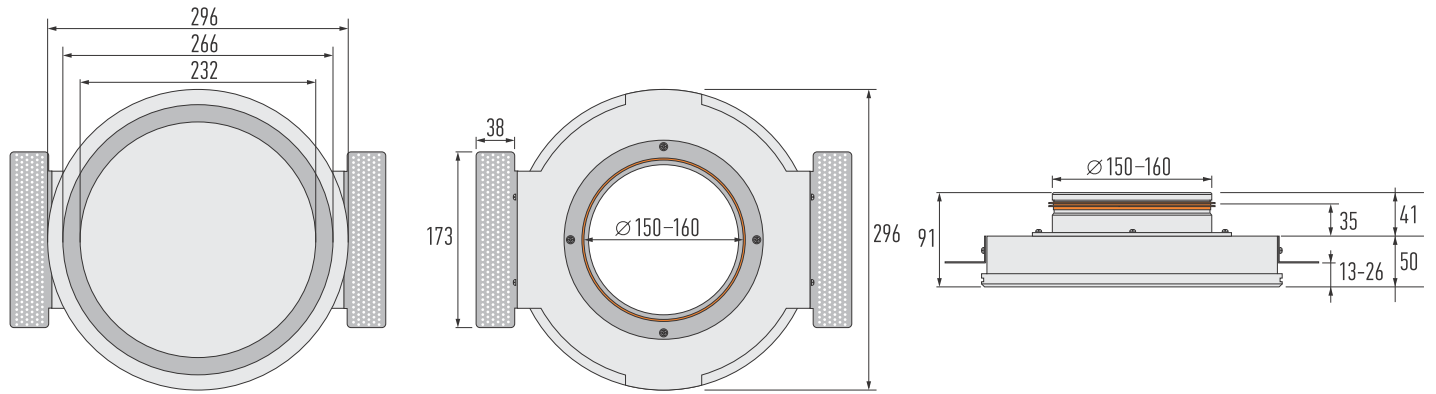

RONDO-150 / 160

Technical data



frameless
air diffusers

RONDO 150 (supply air)

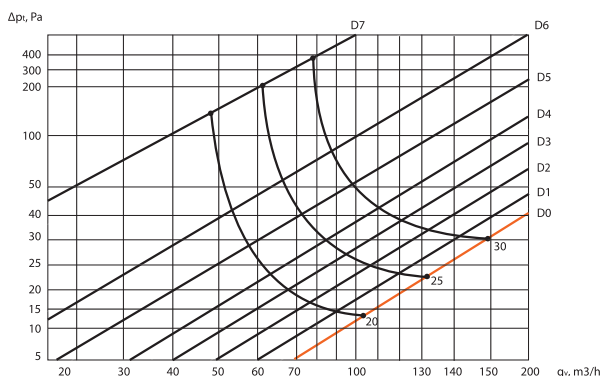

RONDO 150 (exhaust air)

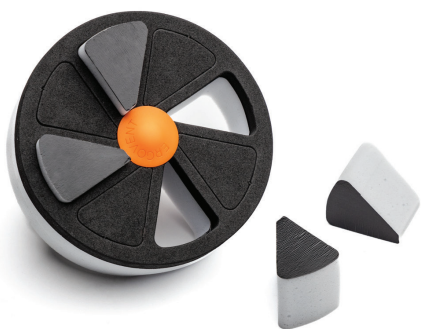
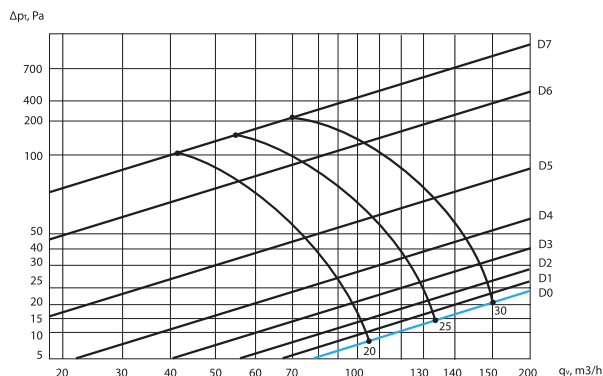

D0 no damper



D1 1 segment



D2 2 segments



D3 3 segments



D4 4 segments / full open



D5 4 segments / 75% open



D6 4 segments / 50% open



D7 4 segments / 25% open

RONDO 150
velocity, m/s

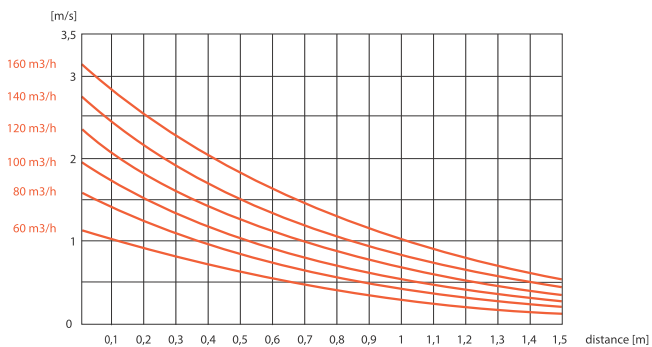

Scan QR code to download the installation instructions.